

U P S

**Uninterruptible Power System
Unterbrechungsfreie Stromversorgung**

ON LINE Network Protection

ON LINE Pure Sine Wave Output UPS

700VA/ 1000VA/ 1500VA/ 2KVA/ 3KVA

■ USER'S MANUAL ■

TABLE OF CONTENTS

INTRODUCTION	ii
1. IMPORTANT SAFETY INSTRUCTIONS.....	1
2. PRESENTATION.....	2
FRONT PANEL	
REAR PANEL	
OUTPUT	
3. INSTALLATION.....	5
4. OPERATION.....	9
5. ALARMS.....	10
6. SOFTWARE.....	11
7. MAINTENANCE AND STORAGE.....	12
8. REPLACEMENT AND INSTALLATION.....	13
APPENDIX A. TROUBLESHOOTING.....	15
APPENDIX B. SPECIFICATIONS.....	16

Revision 1.0
Revised September 15, 2000.

INTRODUCTION

SAVE THESE INSTRUCTIONS

Please read and save this manual!

Thank you for selecting this uninterruptible power system (UPS). It provides you with a perfect protection for connected equipment. The manual is a guide to install and use the UPS. It includes important safety instructions for operation and correct installation of the UPS. If you should have any problems with the UPS, please refer to this manual before calling customer service.

Please save or recycle the packaging materials!

The UPS's shipping materials are designed with great care to provide protection within delivery. These materials are invaluable if you ever have to return the UPS for service. Damage happened during transit is not covered under the warranty.

Intelligent microprocessor control

The product is an advanced on-line UPS based on dual-microprocessor control. This means that it operates with the newest technology, high performance and powerful function.

The on-line UPS is an intelligent protector and provides pure, reliable AC power to the critical loads - protecting them from utility power blackout, swells, sags, surges and interference. The loads could include sensitively medical instruments, computers, telecommunication systems, and industrially automatic equipment. Under power normal condition, the on-line design enables the system to adjust and filter power fluctuations continuously and automatically. In the event of power failure, it can provide immediate back-up power from the batteries without any interruption. When overload or UPS malfunction, the system will automatically transfer into bypass mode and keep supplying output equipment with utility power; if overload situation is relieved, it will automatically transfer back to inverter mode when malfunction is resolved by restarting the UPS. Complete transference will be achieved within 4m seconds, with no interruption.

Beside this, when the utility power is connected, the charger would work automatically even under power switch is OFF. Furthermore, in order to save the battery energy, UPS can automatically turn it off under backup mode if none of the connected loads is operating.

Advanced battery management

The visual and audible indications of the UPS present the battery's status including capacity degree and battery condition. Self-test function let UPS detect a weak battery before it is put into service. The UPS normally perform a self-test at power up and manual self-test condition. Self-test function can be conducted manually with the ON/TEST switch at any time.

Advanced monitoring software

The on-line UPS and UPS-MON series monitoring software (optional kits) make your computer operate intelligent and provide you with the ability of perfect protection of your critical devices. The software is available for most operation systems and is supplied with a communication cable that connects to the UPS.

Note: There is no guarantee that interference to radio/TV will not occur in a particular installation. If this UPS causes interference to radio or television reception, which can be determined by turning the UPS off and on, the user is encouraged to try to correct the interference by one or more of following measures:

1. Connect the equipment to an outlet at a circuit different from the connected radio/TV.
2. Increase the separation between the equipment and the receiver or reorient the receiving antenna.

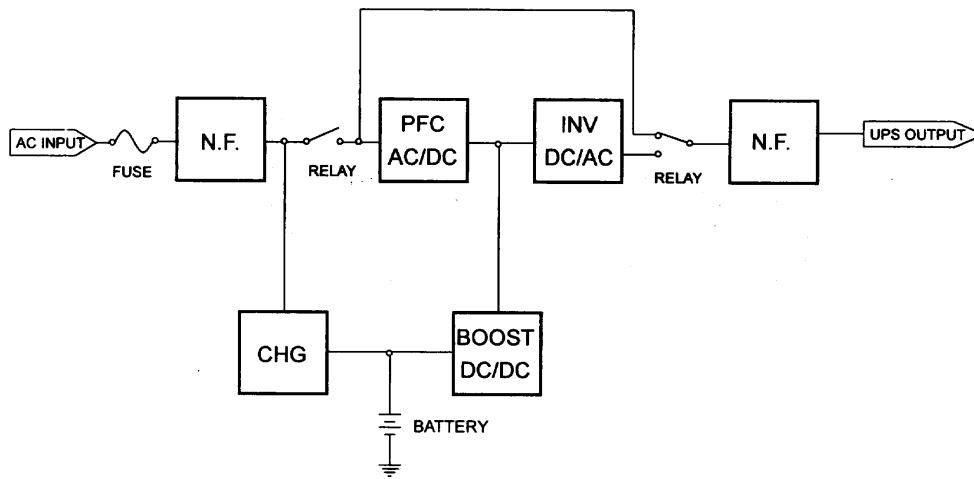

Figure. System block diagram.

1. IMPORTANT SAFETY INSTRUCTIONS

IMPORTANT SAFETY INSTRUCTIONS

- **WARNING (Controlled Environment)** : Intend for installation in a controlled environment.
- **WARNING (Fuses)**: To reduce the risk of fire, replace only with the same type and rating of fuse.
- **CAUTION (Live Heat Sink)**: Risk of electric shock-Heat sink is live. Disconnect unit before servicing.
- **CAUTION (Size of Branch Circuit Over current Protection)**: To reduce the risk of fire, connect only to a circuit provided with 50 amperes for Model ULT-3000 and 35 amperes for Model ULT-2000 maximum branch circuit over current protection in accordance with National Electric Code, ANSI/NFPA 70.
- **CAUTION**: Do not dispose of batteries in a fire, the battery may explode.
- **CAUTION**: Do not open or mutilate the battery, released electrolyte is harmful to the skin and eyes. It may be toxic.
- **CAUTION**: A battery can present a risk of electric shock and high short circuit current. The following precaution should be observed when working on batteries
 - Remove watches, rings or other metal objects.
 - Use tools with insulated handles.
 - Wear rubber gloves and boots.
 - Do not lay tools or metal parts on top of batteries.
 - Disconnect charging source prior to connecting or disconnecting battery terminals.
- **DANGER (Battery Supplies Over 60V)**: Risk of electric shock. Do not touch uninsulated battery terminals.
- Servicing of batteries should be performed or supervised by personnel knowledgeable of batteries and the required precautions. Keep unauthorized personnel away from batteries.
- When replacing batteries, replace with the same number and type.
- The right way to de-energize the UPS properly in an emergency is to move the I/O switch to the OFF position and disconnect the power cord from the mains supply.
- Use six No. 8 AWG type TW cable, trade size, 3/4 in. conduit, 60°C copper wires for input and output field wiring. (2000VA/3000VA & 2000VA/3000VA RM, 100/110/115/120 VAC)
- Use tightening torque of 40Nm to secure input and output wires to terminal block. (2000VA/3000VA & 2000VA/3000VA RM, 100/110/115/120 VAC)

2. PRESENTATION

Front LED Panel

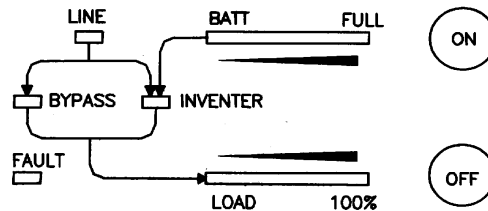

Front LCD Panel

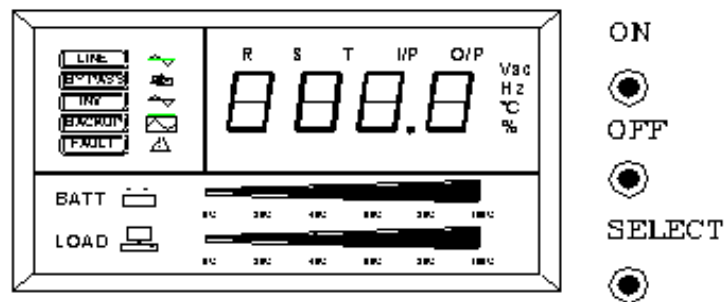

2.1 "LINE" indicator

The indicator illuminates when the line input voltage is normal.

2.2 "BY PASS" indicator

The indicator illuminates when the loads are supplied from the utility power, through the by-pass direction.

2.3 "INV" or "INVERTER" indicator

The indicator illuminates when the output power of UPS is supplied from the inverter circuit.

2.4 "BACKUP" indicator (LCD Panel only)

The indicator illuminates when the power is supplied from the batteries.

2.5 “FAULT” indicator

It shows something wrong concerning about the UPS.

2.6 “ON” button

With the UPS plugged in, press the “ON” button to turn on the UPS and power the loads. “ON” also activates the UPS’s self-test and utility line voltage displays.

2.7 “OFF” button

Press the OFF button to turn off the UPS and the loads.

2.8 “SELECT” button (LCD Panel only)

The relevant value appears on the upper screen. There are four display modes can be selected.

- Output voltage display
- Input voltage display
- Input frequency
- Temperature inside the UPS

2.9 “BATT” bar graph (RECTANGLE INDICATOR)

The rectangle indicator shows the percentage of battery capacity.

2.10 “LOAD” bar graph (RECTANGLE INDICATOR)

The indicator shows the power being drawn by the load.

2.11 “FAULT” codes (LCD Panel only)

The relevant value appears at the upper screen. There are seven kinds of fault modes can be displayed.

- E01: Warning of fail output
- E02: Warning of wrong temperature
- E03: Warning of output short circuit
- E04: Warning of overload (exceeding 150%)
- E05: Warning of mistaken +/- DC Bus
- E06: Warning of wrong electrical charging voltage
- E07: Warning of batteries mistake

<u>Load Indicator</u>	<u>% of Load Value</u>	<u>Battery Indicator</u>	<u>% of Bat Level</u>
Light no.5	over 96%	Light no.5	over 91 %
Light no.4	76-95 %	Light no.4	76-90 %
Light no.3	51-75 %	Light no.3	51-75 %
Light no.2	26-50 %	Light no.2	26-50%
Light no.1	10-25 %	Light no.1	0-25%

Rear Panel (Tower type)

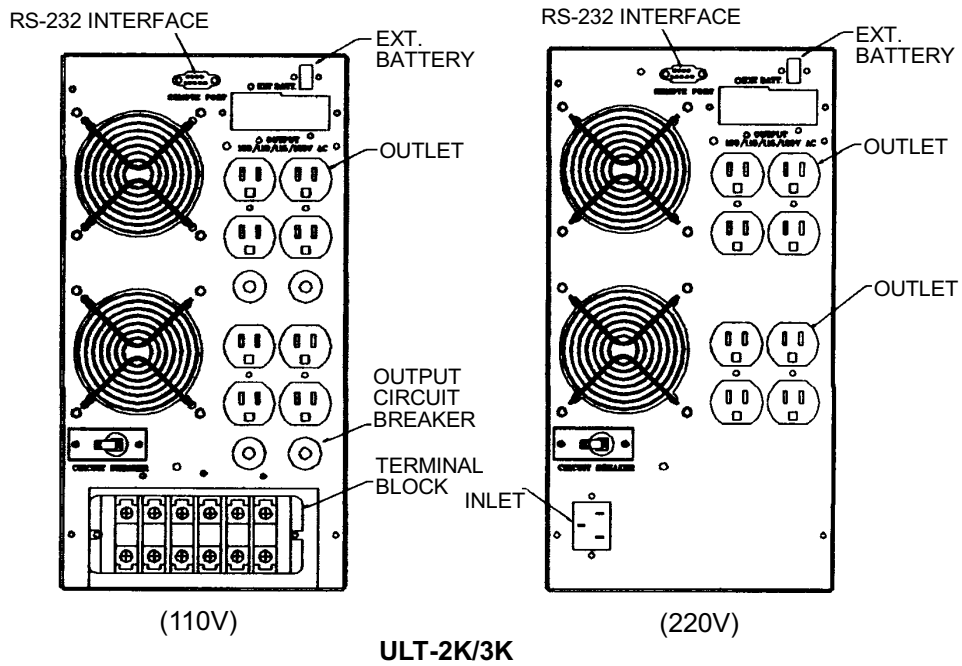
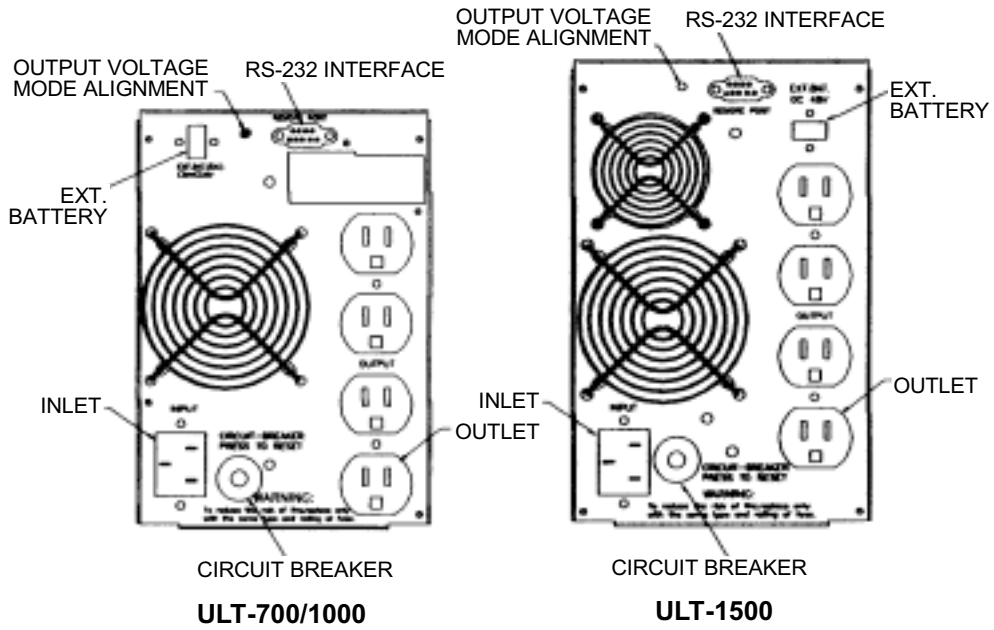

Rear Panel (Rack-Mount type)

FRONT VIEW

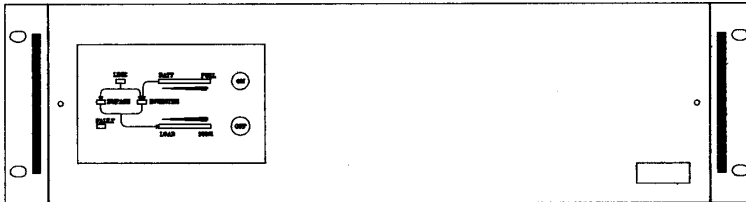

REAR VIEW

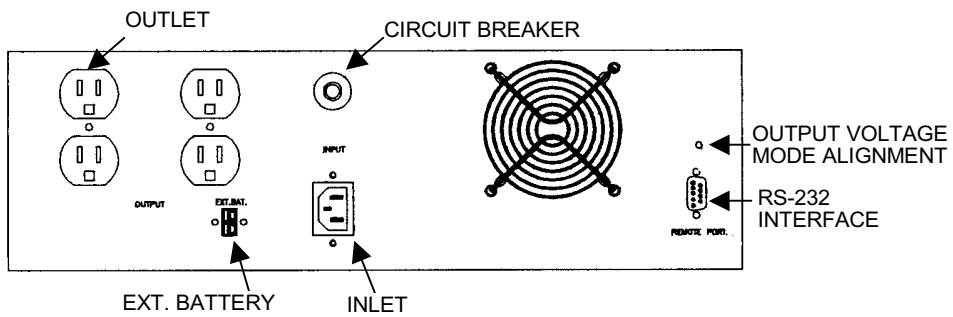

700 / 1000 RM

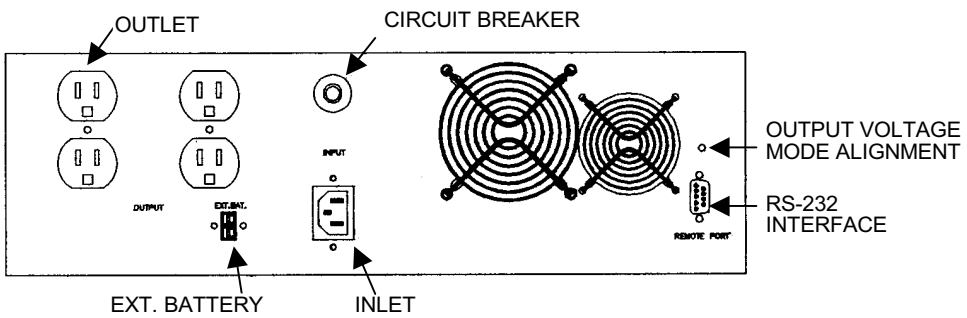

1500 RM

Rear Panel (Rack-Mount type)

REAR VIEW

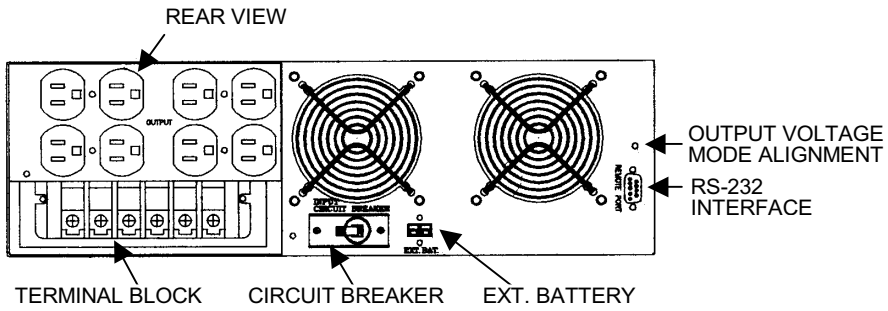

100 / 110 / 115 / 120V SYSTEM
2K / 3K RM

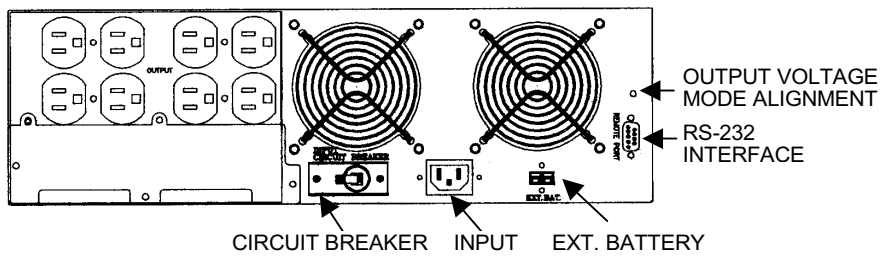

208 / 220 / 230 / 240V SYSTEM
2K / 3K RM

2.12 EXTERNAL BATTERY PACK CONNECTOR (optional)

Batteries: Can be connected with external battery pack.

CAUTION: Use only factory supplied or authorized connecting cable for external battery!

2.13 SNMP INTERFACE PORT (optional)

Provide the SNMP adapters for 10-BaseT Ethernet and Token Ring connectors. Through RS232 communication port, the SNMP adapter make your UPS becomes "SNMP manageable", provide a real time UPS and power status information for the network manager.

Note: It's not necessary to use this function.

CAUTION: Use only factory supplied or authorized SNMP monitoring cable!

2.14 OUTPUT POWER RECEPTACLES

2.15 AC INPUT POWER RECEPTACLE

2.16 INPUT CIRCUIT BREAKER

It trips when the connected loads exceed the protected receptacle's capacity, The center plungers of the circuit breakers extend when tripped.

2.17 SITE WIRING FAULT INDICATORS (RED LED)

It comes on when the UPS is connected to an improperly wired AC power outlet.

Note: This device is available on 110 Vac model only.

2.18 COMPUTER INTERFACE

Provide both RS-232 and relay signal to support NOVELL, UNIX, DOS, WINDOWS and other operating systems.

2.19 "TERMINAL"

Input: Connect the input voltage

Output: Connect the output voltage.

3. INSTALLATION

Inspect the UPS upon receipt. The packaging is recyclable; keep it for reuse or be disposed of properly.

3.1 Placement

Install the UPS in a protected area with adequate flowing air and free of excessive dust. Do not operate the UPS where the temperature and humidity is out of the specified limits.

3.2 Connect Computer Interface (optional)

UPS-MON series software (or other power management software) and an interface kits can be used with this UPS. Use only kits supplied or approved by the manufacturer. If used, connect the interface cable to the 9-pin computer interface port on the back panel of the UPS.

Note: Computer interface connection is optional. The UPS works properly without a computer interface connection.

CAUTION: Use only factory supplied or authorized UPS monitoring cable!

3.3 Connect external battery pack (optional)

Before connecting, make sure the external battery pack and the connector cable are compatible.

Note: External battery connection is not necessary. The UPS works properly without external battery pack connection. (For standard model only)

CAUTION: Use only factory supplied or external battery connection cable!

3.4 Charge the battery

The UPS charges its battery whenever it is connected to utility power. For best results, charge the battery for 8 hours in the initial use.

3.5 Connect to Utility

See figure a. Please check the following items to connect the AC input power to terminal block and power up the UPS.

- 3.5.1. Only to connect a circuit provided with 50 amperes for Model ULT-3000 and 35 amperes for Model ULT-2000 maximum branch circuit overcurrent protection in accordance with National Electric Code, ANSI/NFPA 70
- 3.5.2. Use six No. 8 AWG type TW cable, trade size, 3/4 in. conduit, 60°C copper wires for input and output field wiring. (2000VA/3000VA & 2000VA/3000VA RM, 100/110/115/120 VAC)
- 3.5.3. Use tightening torque of 40Nm to secure input and output wires to terminal block. (2000VA/3000VA & 2000VA/3000VA RM, 100/110/115/120 VAC)

3.6 Connect the loads

Connect the loads with the terminal block at the rear of the UPS. To use the UPS as a master on/off switch, make sure all of the loads are switched on.

CAUTION: Never connect a laser printer or plotter to the UPS with other computer equipment. A laser printer or plotter periodically draws significantly more power than when its idle status, and may overload the UPS.

4. OPERATION

4.1 Switch on

While utility input is connected to the UPS, press the "ON" button and keep pressing over than 0.5 second. After that, connect the electrical cords of the equipment that is going to be used such as computer or monitor with the terminal on the rear panel of UPS.

Don't overload the machine with all the equipment used. The buzzer will beep continuously to indicate overload status. UPS will shut down automatically to protect the machine.

Attention: If the power of UPS isn't supplied by utility but by the internal batteries to engage the UPS, press the "ON" button and keep pressing for over 3 seconds.

CAUTION: Never connect a laser printer or plotter to the UPS with other computer equipment. A laser printer or plotter periodically draws significantly more power than when its idle status, and may overload the UPS.

4.2 Switch off

By pressing and holding OFF button until the "LINE NORMAL" or "BACK UP" LED off.

4.3 Silence

When UPS is under "BACKUP" mode, press "ON" button more than 1 second to silence the audible alarm. (The function is disable when UPS is under condition of "LOW BATTERY" or "OVERLOAD")

Note: At back-up mode, UPS can be automatically turned off if none of the connected loads is operating.

5. ALARM

5.1 “BACKUP”(slow alarm)

When the UPS is working under “BACKUP” mode, the UPS would emit audible alarm. The alarm stops when the UPS is return to “LINE” mode operation. Anyone can stop the alarm by press the “ON” button during backup mode.

Attention: The alarm of “BACKUP” is going to beep every four seconds. (Slow-speed beep).

Attention: The UPS provides mute function for the warning. When the beeping sound occurs, press "ON" to stop it; and press "ON" again to regain the sound.

5.2 “LOW BATTERY” (rapid alarm)

In the “BACKUP” mode, when the energy of battery becomes to lower level. (about 20%~30%) The UPS beeps rapidly until the UPS shuts down from battery exhaustion or returns to “LINE” mode operation.

Attention: The alarm of the batteries caused by low voltage beeps every second. (Fast-speed beep).

Attention: The rapid alarm under “LOW BATTERY” condition can't be erased.

5.3 “FAULT” (continuous alarm)

Here is listing some “FAULT” conditions as following for reference.

5.3.1 “FAULT code 04” (LCD Panel only)

When the UPS is working under overload condition (the connected loads exceed the maximum rated capacity), the UPS will emit continuous alarm to warn an overload condition. In order to protect the unit and the loads, the UPS will be automatic shutdown. Disconnect nonessential devices from UPS to eliminate the overload alarm.

5.3.2 “FAULT code E07” (LCD Panel only)

The UPS emits continuous beeps and the “FAULT” illuminates if the battery fails within the self-test. See section 8 to replace battery and call your dealer for services.

6. SOFTWARE AND INTERFACE PORT

6.1 Power Monitoring Software

The UPS-MON series software (or other power monitoring software) is applied standard RS-232 interface to perform monitoring functions, and then provides an orderly shutdown of a computer in the event of power failure. Moreover, UPS-MON displays all the diagnostic symptoms on monitor, such as Voltage, Frequency, Battery level and so on. The software is available for DOS, Windows 3.1x, Windows 95, Windows NT V3.5 or later, Novell Netware and others. Call your dealer for more information on computer OS compatible solutions.

6.2 Interface Kits

A series of interface kits is available for operation systems that provide UPS monitoring. Each interface kit includes the special interface cable required to convert status signals from the UPS into signals which individual operating system recognize. The interface cable at UPS side must be connected to REMOTE PORT, at computer side can be either COM 1 or COM 2. The other installation instructions and powerful features please refer to READ.ME file.

CAUTION: Use only factory supplied or authorized UPS monitoring cable!

6.3 The characteristics of computer interface port

The computer interface port has the following characteristics:

The communication port on the back of the UPS may be connected to host computer. This port allows the computer to monitor the status of the UPS and control the operation of the UPS in some cases. Its major functions normally include some or all of the following:

To broadcast a warning when power fails.

To close any open file before the battery is exhausted.

To turn-off the UPS.

Some computers are equipped with a special connector to link with the communication port. In addition, special plug-in cord may be needed. Some computers may need special UPS monitoring software. Contact your dealer for the details on the various interface Kits.

6.4 The pin of computer interface port

The pin of computer interface port has the following characteristics:

- 6.4.1. Pin 5 and 2 are open collector outputs that must be pulled up to a common referenced supply no greater than AC +40V. The transistors are capable of a maximum nonconductive load of DC 25 mA, Use only pin 7 as the common.
- 6.4.2. Pin 5 generates a High to Low signal when the battery inside the UPS has less than 5 minutes back up time left.
- 6.4.3. Pin 2 generates a High to Low signal when the line is fail.
- 6.4.4. The UPS will shut down when a high RS-232 level is sustained on pin 6 for 0.36 seconds.
- 6.4.5. Pin 9 is also the RS-232 data output.
- 6.4.6. Pin 6 is RS-232 data input (RxD)

NOTE:

- 1. Switch rating +40V, 0.15A non-inductive.
- 2. Pin 7 should be connected to ground only.

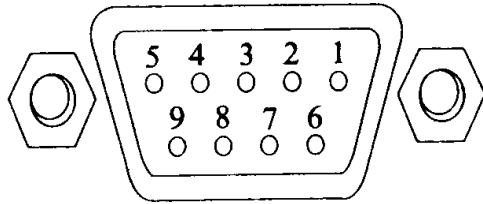

Communicating Interface Port

We provide a standard RS232 line (that is compatible with DB9 line) socket on the rear panel of UPS. That port possesses several signals as explained below:

Pin#	Function Explanation	I/O
2	Power Fail-normally open status, will become closed during active	OUTPUT
4	Reference GND for pin2,5	OUTPUT
5	Battery Low- normally open status, will become closed during active	OUTPUT
6	Remote shutdown UPS-keep this pin at high voltage(+5V~+12V) 500ms to shutdown UPS. Activates at battery mode	INPUT
7	Reference GND for pin6	INPUT

7. MAINTENANCE AND STORAGE

7.1 Maintenance

- 7.1.1. Keep the unit clean and vacuum the ventilation intake periodically.
- 7.1.2. Wipe with soft loose and damp cloth.
- 7.1.3. Check for loose and bad connections monthly.
- 7.1.4. Never leave the unit on an uneven surface.
- 7.1.5. Position the unit to allow at least 10 cm clearance between the rear panel and the wall. Keep the ventilation intake open.
- 7.1.6. Avoid direct sunlight, rain and high humidity.
- 7.1.7. Stay away from fire and extremely hot location.
- 7.1.8. Do not stack materials on top of the unit.
- 7.1.9. The unit should not be exposed to corrosive air.
- 7.1.10. The normal operating temperature is 0-40 °C.

7.2 Storage conditions

Store the UPS covered and upright in a cool and dry location, with its battery fully charged. Before storing, charge the UPS for at least 4 hours. Remove any accessories in the accessory slot and disconnect any cables connected to the computer interface port to avoid unnecessary draining the battery.

7.3 To extend the storage

During the environment where the ambient temperature is -15 to +30 °C (+5 to +86 °F), charge the UPS's battery every 6 months.

During the environment where the ambient temperature is +30 to +45 °C (+86 to +113 °F), charge the UPS's battery every 3 months.

8. REPLACEMENT AND PARK INSTALLATION

8.1 Battery's life of UPS

The battery's life of UPS is about 3-6 years under normal usage.

8.2 Battery Replacement

See figure. UPS and external battery pack.

Once the UPS's battery is no longer useful and must be replaced. Please follow the instructions for easy battery replacement.

8.2.1. Unplug unit from AC power source and disconnect all connected equipment.

8.2.2. Disconnect AC power cord from UPS.

8.2.3. Make serial connection of the battery packs. Make sure they are at proper voltage.

8.2.4. First, connect the electric wire with the ends of the battery packs.

Attention: Do not connect it with the end of UPS, or it will cause an electrical shock. The red wire with a tag should be connected with the positive end(+) of the battery packs; connect the black wire with the negative end(-) of the battery packs.

8.2.5. Connect with the utility while the UPS is at its no-load position.

8.2.6. Connect the battery terminals on the rear panel connector of UPS with the electrical wires of battery series. (See the following picture.)

Attention: The positive/negative ends of the electric wire of batteries should be at the same position as the positive/negative ends of the connector on UPS rear panel. That is, the positive ends of the electrical wire of batteries should be connected with the positive ends of the connector on UPS rear panel; the negative ones with the negative ones of the connector. If not, there will be an explosion danger.

8.2.7. You can now easily remove the battery from the UPS

CAUTION: Do not dispose of battery in fire.

CAUTION: Do not attempt to open the battery.

CAUTION: The following precautions should be taken when replacing the battery

- a. Remove watches, rings, etc...
- b. Use tools with insulated handles

8.2.8. Place your new battery in the same position/direction and reconnect the red wires to positive (+) polarity and black wire to negative (-) polarity.

8.2.9. Please follow steps 5,4 and 3 (in that order) to reconnect the entire unit.

8.2.10. Please follow manual instructions to reconnect your equipment.

APPENDIX A TROUBLESHOOTING

Problems	Possible Reasons	Solutions
1. UPS can't operate after pressing On/Off switches 2. No lights on, no warning sounds	Input power source mistake	Check out the power source
	Non-fuse switch on the rear panel hasn't been opened	Press the non-fuse switch to its "on" position
	Time of pressing the ON button is too short	Keep pressing the ON button over 1 second
	Output short circuit or overload on UPS	Turn off UPS, take off all load to make sure there are no problems on it or any internal short circuit. Keep pressing the ON button over 1 second
Indicates no utility, and it warns every several seconds	No power source input	Check out the input power source
	Non-fuse switch on the rear panel hasn't been opened	Press the Non-fuse switch to its "on" position
Fault light is on, the buzzer keeps beeping	UPS is broken	Contact the dealer or service center for help
Buzzer keeps beeping	Overload	Take off some load
Utility Indicating light is shining	There is an open circuit on UPS input protector	Move the Input Non-fuse switch back to its normal position, re-engage UPS
	The voltage of utility is exceeding UPS input range	Save the digital data and shutdown the applying program to make sure utility is within UPS range
Available time of the batteries is too short	1. Batteries haven't been charged 2. UPS overload 3. Batteries are aged and can't be charged fully	Keep UPS "ON" for over 3 hours to recharge the batteries. Check out the loading and take off any non-crucial load equipment
	The charger is out of order	Contact the dealer or service center for help
The battery's light is flashing when the power of UPS is supplied by utility.	The voltage of batteries is too low or the batteries haven't been connected	Check out the batteries part of UPS, make sure they are well connected. If there is any damage on battery packs, replace new ones ASAP

APPENDIX B SPECIFICATIONS

Tower model		700VA	1000VA	1500VA	2000VA	3000VA
19" rack-mount model		700VA RM	1000VA RM	1500VA RM	2000VA RM	3000VA RM
Power Rating	P.F.=0.7	700VA/490W	1KVA/700W	1.5KVA/1050W	2KVA/1400W	3KVA/2100W
AC Input	Voltage	100V:76V-130V 110V:80V-138V 115V:83.5V-140V 120V:87V-140V 208V:152V-260V 220V:160V-276V 230V:167V-280V 240V:174V-280V				
	Frequency	50Hz or 60Hz \pm 3Hz				
	Phase	Single phase				
	Power factor	0.98				
Battery	Dc voltage	24V	36V	48V	72V	96V
	Back-up Time Full Load	5min	7min	5min	9min	7min
	Half Load	12min	20min	17min	20min	15min
	Type	Sealed lead acid battery, free maintenance				
	Protection	Cut off without draining any current when battery low				
	Recharge time	About 8 hours to 90% after fully discharged				
AC output	Frequency	50Hz/60Hz (Auto detection)				
	Voltage	100/110/115/120V or 208/220/230/240V				
	Voltage regulation	\pm 2% (except 3000VA/110V \pm 3%, 3000VA RM/110V \pm 3%)				
	Frequency stability	\pm 0.5%				
	Power factor	0.7 (lagging)				
	Harmonic distortion	<3% of T.H.D. at linear load				
	Overload detection	105% for 10 seconds and 130% \pm 10% for 300ms				
	Crest factor ratio	3:1				
Efficiency	AC to AC	>85%				
Transfer	Power failure or recovery	0ms				
	Overload disappear	Auto transfer to UPS				
Noise Level	1m. distance	<45dBA			<52dBA	
LED Indicators	Status	line input (green), inverter output (green), bypass (yellow), fault (red)				
	Battery capacity	4 green, 1 red LED and red bar LEDs indicated low capacity				
	Load level	4 green, 1 red LED and red bar LEDs indicated overload capacity				
Alarm	Battery discharge	The first warning will beep every 4 seconds to indicate battery in use. The second warning will beep every 1 second to signal battery low condition.				
	UPS fault	Continuous beeping sound				

Tower model		700VA	1000VA	1500VA	2000VA	3000VA
19" rack-mount model		700VA RM	1000VA RM	1500VA RM	2000VA RM	3000VA RM
Environment	Temperature	0°C -40°C				
	Humidity	0%-95% (Non condensing)				
Interface	Support both RS232&dry contact signal	Provide power management & diagnostic functions including power status, Battery low, schedule UPS ON/OFF, battery-load level display and more compatible with Windows 95/98/NT, Novell, Unix and other popular systems.				
Physical size WxDxH(mm)	Tower model	145x400x220(5.7"x15.7"x8.7")			192x460x385(7.6"x18.1"x15.2")	
	19" rack-mount	483x400x130(19"x15.7"x5.1")			483x470x130"(19"x18.5"x5.1")	
Net weight (kg)	Tower model	8.9(19.6lb)	11.3(24.9lb)	13.9(30.6lb)	28.1(61.8lb)	33.3(73.3lb)
	19" rack-mount	21.1(46.5lb)	23.5(51.7lb)	26.1(57.6lb)	27(59.4lb)	31(68.2lb)

©2000.09.05 Version 1.0 Powercom Co., Ltd. All right Reserved.
All trademarks are property of their respective owners. Specifications subject to change without notice.

